

| Illustration | Item number | Description | PU PU/large bundle |
|---|-------------------------|---|--|
|  | PRO-00100 | CD profile 60/27/0.6 rK, 1,190 mm | 12 pcs. (14.28 m) 180 pcs. (214.20 m) |
| | PRO-00101 | CD profile 60/27/0.6 rK, 2,600 mm | 12 pcs. (31.20 m) 180 pcs. (468.00 m) |
| | PRO-00102 | CD profile 60/27/0.6 rK, 3,100 mm | 12 pcs. (37.20 m) 180 pcs. (558.00 m) |
| | PRO-00103 | CD profile 60/27/0.6 rK, 3,600 mm | 12 pcs. (43.20 m) 180 pcs. (648.00 m) |
| | PRO-00104 | CD profile 60/27/0.6 rK, 4,000 mm | 12 pcs. (48.00 m) 180 pcs. (720.00 m) |
| | PRO-00105 | CD profile 60/27/0.6 rK, 4,600 mm | 12 pcs. (55.20 m) 180 pcs. (828.00 m) |
| | PRO-00001 | CD profile 60/27/0.6 rK, custom length | |
| | | | Manufactured according to EN 14195 |
|  | PRO-00106 | UD profile 28/27/0.6, 3,000 mm Wall connection profile for CD profiles | 16 pcs. (48.00 m) 288 pcs. (864.00 m) |
|  | PRO-00004 on request | <p>CD profile 60/27/0.6 rK, concave, 4,000 mm Bend radius min. 500 mm - 4,000 mm</p> <p>CD profile 60/27/0.6 rK, concave, 4,000 mm Bend radius min. 4,000 mm or special lengths</p> <p>The minimum order quantity per curved radius is 20 linear metres.</p> <p>For production reasons, curved CD profiles come with 150 mm straight sections on each end.</p> <p>Product realisation details: radius (r) + chord (s) or radius (r) + rise (h) or chord (s) + rise (h) or radius (r) + fixed length (b)</p>  <p style="text-align: right;">concave</p> | |
|  | PRO-00003 on request | <p>CD profile 60/27/0.6 rK, convex, 4,000 mm Bend radius min. 500 mm - 4,000 mm</p> <p>CD profile 60/27/0.6 rK, convex, 4,000 mm Bend radius min. 4,000 mm or special lengths</p> <p>The minimum order quantity per curved radius is 20 linear metres.</p> <p>For production reasons, curved CD profiles come with 150 mm straight sections on each end.</p> <p>Product realisation details: radius (r) + chord (s) or radius (r) + rise (h) or chord (s) + rise (h) or radius (r) + fix length (b)</p>  <p style="text-align: right;">convex</p> | |

| Illustration | Item number | Description | Application | PU PU/pallet |
|---|-------------|--|---|------------------------------|
|  | 101535 | Anchor fast suspension with compression spring, CD 60/27 Initial testing according to EN 13964, 0.25 kN |  | 100 pcs./PU 84 PU/pallet |
|  | 101539 | Anchor fast suspension, CD 60/27 Initial testing according to EN 13964, 0.25 kN |  | 100 pcs./PU 84 PU/pallet |
|  | 101541 | Anchor suspension, 80 mm, CD 60/27 Initial testing according to EN 13964, 0.25 kN |  | 100 pcs./PU 96 PU/pallet |
|  | 101537 | Anchor suspension, 170 mm, CD 60/27 Initial testing according to EN 13964, 0.25 kN |  | 100 pcs./PU 144 PU/pallet |
|  | 101543 | Fastening clip, CD 60/27 Initial testing according to EN 13964, 0.15 kN Tolerance compensation up to 20 mm possible |  | 100 pcs./PU 32 PU/pallet |
|  | 101621 | Direct mounting clip, CD 60/27 Straps without screws Initial testing according to EN 13964, 0.25 kN Straps with 2 screws LN 3.5 x 9.5 mm Initial testing according to EN 13964, 0.40 kN |  | 100 pcs./PU 84 PU/pallet |
|  | 101601 | Direct suspended bracket, 50 mm, 4-hole, CD 60/27 |  | 100 pcs./PU 72 PU/pallet |
| | 101602 | Direct suspended bracket, 120 mm, 4-hole, CD 60/27 | | 100 pcs./PU 96 PU/pallet |
| | 101606 | Direct suspended bracket, 200 mm, 4-hole, CD 60/27 Initial testing according to EN 13964, 0.40 kN Delivery includes unbent product | | 100 pcs./PU 72 PU/pallet |
|  | 101614 | Direct suspended bracket, 50 mm, 4-hole, wood 50/30 |  | 100 pcs./PU 72 PU/pallet |
| | 101615 | Direct suspended bracket, 120 mm, 4-hole, wood 50/30 | | 100 pcs./PU 96 PU/pallet |
| | 101618 | Direct suspended bracket, 200 mm, 4-hole, wood 50/30 Initial testing according to EN 13964, 0.40 kN Delivery includes unbent product | | 100 pcs./PU 72 PU/pallet |

| Illustration | Item number | Description | Application | PU PU/pallet |
|---|-------------|---|---|------------------------------|
|  | 100923 | Direct suspended bracket, adjustment 40 - 70 mm, CD 60/27 Including locking pins Initial testing according to EN 13964, 0.47 kN |  | 50 pcs./PU 66 PU/pallet |
|  | 100924 | Direct suspended bracket, adjustment 59 - 108 mm, CD 60/27 Including locking pins Initial testing according to EN 13964, 0.58 kN |  | 50 pcs./PU 48 PU/pallet |
|  | 101567 | Cross connector, CD 60/27 Initial testing according to EN 13964, 0.40 kN Delivery includes unbent product |  | 100 pcs./PU 148 PU/pallet |
|  | 101575 | UA cross connector, UA 50/CD 60/27 Initial testing according to EN 13964, 0.40 kN Delivery includes unbent product |  | 100 pcs./PU 148 PU/pallet |
|  | 101565 | Anchor bracket, CD 60/27 Initial testing according to EN 13964, 0.25 kN |  | 100 pcs./PU 96 PU/pallet |
|  | 101573 | Twisting anchor bracket, CD 60/27 Initial testing according to EN 13964, 0.25 kN  on-site angle adjustment from 30° - 150° |  | 100 pcs./PU 96 PU/pallet |
|  | 100912 | Support clip, CD 60/27 Clamping width up to 17 mm |  | 50 pcs./PU 136 PU/pallet |
|  | 100915 | Adjustable vibration bracket, 30 mm, CD 60/27 |  | 100 pcs./PU 102 PU/pallet |
| | 100916 | Adjustable vibration bracket, 45 mm, CD 60/27 | | 100 pcs./PU 102 PU/pallet |
| | 100917 | Adjustable vibration bracket, 60 mm, CD 60/27 | | 100 pcs./PU 66 PU/pallet |
| | 100914 | Adjustable vibration bracket, 90 mm, CD 60/27 Application: wall structures | | 100 pcs./PU 48 PU/pallet |

| Illustration | Item number | Description | Application | PU PU/pallet |
|--------------|-------------|--|-------------|-----------------------------|
| | 101589 | Universal connector, unbent, CD 60/27 Delivery includes unbent product | | 100 pcs./PU 84 PU/pallet |
| | 101586 | Connector, 80 mm, CD 60/27 | | 100 pcs./PU 32 PU/pallet |
| | 101595 | Connector, lengthwise, CD 60/27 | | 100 pcs./PU 48 PU/pallet |
| | 101579 | Angled connector, flat, CD 60/27 For on-site angle adjustment | | 100 pcs./PU 24 PU/pallet |
| | 101583 | Angled connector 90°, CD 60/27 Angle default setting is 90° | | 100 pcs./PU 24 PU/pallet |
| | 101585 | Angled connector 45° - 179°, CD 60/27 Angle default setting according to customer specification | | 100 pcs./PU 24 PU/pallet |
| | 101587 | Vertical connector, T-connector, CD 60/27 T-connector movable within the CD profile, suitable, for example, for the installation of luminaire boxes | | 100 pcs./PU 24 PU/pallet |
| | 101504 | Locking pin for vernier | | 100 pcs./PU |

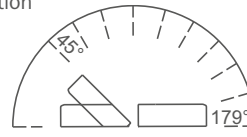
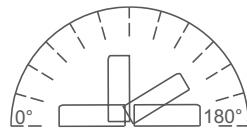







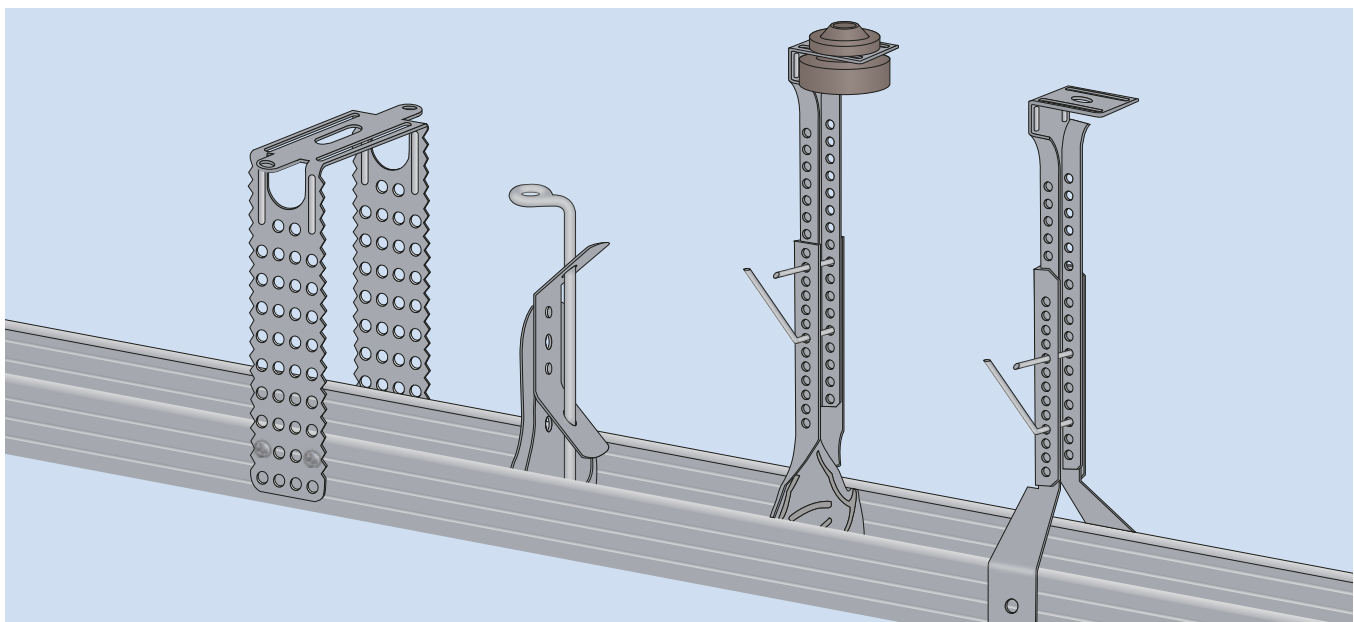

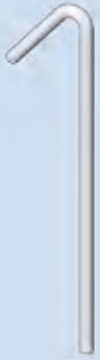





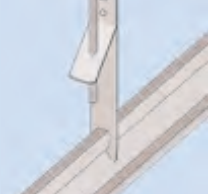

| Illustration | Item number | Description | Application | PU PU/pallet |
|--------------|--|--|-------------|---|
| | 100981 | Vernier security pin Initial testing according to EN 13964, 0.40 kN | | 100 pcs./PU 576 PU/pallet |
| | 100931 100932 100933 100934 100935 100936 100937 100938 100939 100940 100941 100942 | Eyelet wire, 125 mm Eyelet wire, 250 mm Eyelet wire, 375 mm Eyelet wire, 500 mm Eyelet wire, 750 mm Eyelet wire, 1,000 mm Eyelet wire, 1,250 mm Eyelet wire, 1,500 mm Eyelet wire, 1,750 mm Eyelet wire, 2,000 mm Eyelet wire, 2,500 mm Eyelet wire, 3,000 mm Custom lengths on request Eyelet wire according to EN 13964 | | 100 pcs./PU 300 PU/pallet 200 PU/pallet 150 PU/pallet 100 PU/pallet 100 PU/pallet 100 PU/pallet 100 PU/pallet 50 PU/pallet 50 PU/pallet 50 PU/pallet |
| | 101647 101650 101653 101656 101659 101662 101665 101668 101670 101673 101675 101677 101678 101680 101681 101683 101684 101686 101688 | Vernier top part, 200 mm, X = 130 Vernier top part, 300 mm, X = 230 Vernier top part, 400 mm, X = 330 Vernier top part, 500 mm, X = 430 Vernier top part, 600 mm, X = 530 Vernier top part, 700 mm, X = 630 Vernier top part, 800 mm, X = 730 Vernier top part, 900 mm, X = 830 Vernier top part, 1,000 mm, X = 930 Vernier top part, 1,100 mm, X = 1,030 Vernier top part, 1,200 mm, X = 1,130 Vernier top part, 1,300 mm, X = 1,230 Vernier top part, 1,400 mm, X = 1,330 Vernier top part, 1,500 mm, X = 1,430 Vernier top part, 1,600 mm, X = 1,530 Vernier top part, 1,700 mm, X = 1,630 Vernier top part, 1,800 mm, X = 1,730 Vernier top part, 1,900 mm, X = 1,830 Vernier top part, 2,000 mm, X = 1,930 Custom lengths on request Initial testing according to EN 13964, 0.40 kN continuous perforation | | 100 pcs./PU 240 PU/pallet 120 PU/pallet 100 PU/pallet 80 PU/pallet 60 PU/pallet 50 PU/pallet 40 PU/pallet 30 PU/pallet 30 PU/pallet 25 pcs./PU 25 pcs./PU 25 pcs./PU 25 pcs./PU 25 pcs./PU 25 pcs./PU 25 pcs./PU 25 pcs./PU 25 pcs./PU 25 pcs./PU 25 pcs./PU 25 pcs./PU 25 pcs./PU 25 pcs./PU 25 pcs./PU Pallet units on request from 25 pcs./PU |
| | 101646 | Vernier connector, 90 mm Initial testing according to EN 13964, 0.40 kN | | 100 pcs./PU 96 PU/pallet |

| Illustration | Item number | Description | Application | PU PU/pallet |
|---|-------------|---|---|------------------------------|
|  | 100980 | Vernier rod, 3,000 mm Initial testing according to EN 13964, 0.40 kN |  | 25 pcs./PU |
|  | 100977 | Vernier coupling Extension max. 170 mm |  | 100 pcs./PU |
|  | 101549 | Vernier hanger, CD 60/27 Initial testing according to EN 13964, 0.40 kN |  | 100 pcs./PU 32 PU/pallet |
| | 101553 | Vernier hanger, CD 60/27, incl. security pin Initial testing according to EN 13964, 0.40 kN | | 100 pcs./PU 32 PU/pallet |
|  | 101557 | Vernier hanger, UA 50 Initial testing according to EN 13964, 0.40 kN |  | 100 pcs./PU 32 PU/pallet |
| | 101560 | Vernier hanger, UA 50, incl. security pin Initial testing according to EN 13964, 0.40 kN | | 100 pcs./PU 32 PU/pallet |
|  | 101588 | Vernier bottom part, CD 60/27 Initial testing according to EN 13964, 0.25 kN |  | 100 pcs./PU 108 PU/pallet |
|  | 101625 | Vernier bottom part, diagonal pull, rotating, CD 60/27 Initial testing according to EN 13964, 0.25 kN Excellent suited for multiple diagonal sus- pension, e.g. in staircases, fully rotating (Due to diagonal suspension, always use tapping screws LN 9.5 for fixing) |  | 100 pcs./PU 32 PU/pallet |
|  | 101623 | Direct mounting vibration clip, 4 mm, CD 60/27 Straps without screws Initial testing according to EN 13964, 0.25 kN Straps with 2 screws LN 3.5 x 9.5 mm Initial testing according to EN 13964, 0.40 kN |  | 100 pcs./PU 32 PU/pallet |
|  | 101612 | Direct vibration hanger, 50 mm, 4-hole, CD 60/27 |  | 100 pcs./PU 24 PU/pallet |
| | 100919 | Direct vibration hanger, 120 mm, 4-hole, CD 60/27 | | 100 pcs./PU 32 PU/pallet |
| | 100921 | Direct vibration hanger, 200 mm, 4-hole, CD 60/27 Initial testing according to EN 13964, 0.40 kN Delivery includes unbent product | | 100 pcs./PU 15 PU/pallet |





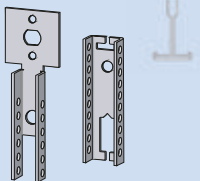
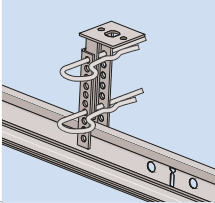
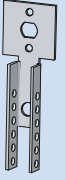
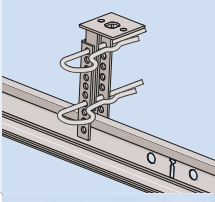

| Illustration | Item number | Description | Application | PU PU/pallet |
|--------------|--|---|-------------|---|
| | 101628 101630 101632 101634 101636 101638 | Eyelet wire, 125 mm Eyelet wire, 250 mm Eyelet wire, 375 mm Eyelet wire, 500 mm Eyelet wire, 750 mm Eyelet wire, 1,000 mm Custom lengths on request Eyelet wire according to EN 13964 with vibration element 4 mm | | 100 pcs./PU 180 PU/pallet 96 PU/pallet 42 PU/pallet 28 PU/pallet 24 PU/pallet 24 PU/pallet |
| | 101648 101651 101654 101657 101660 101663 101666 101804 101671 | Vernier top part, 200 mm, X = 130 Vernier top part, 300 mm, X = 230 Vernier top part, 400 mm, X = 330 Vernier top part, 500 mm, X = 430 Vernier top part, 600 mm, X = 530 Vernier top part, 700 mm, X = 630 Vernier top part, 800 mm, X = 730 Vernier top part, 900 mm, X = 830 Vernier top part, 1,000 mm, X = 930 Custom lengths on request Initial testing according to EN 13964, 0.40 kN continuous perforation with vibration element 4 mm | | 100 pcs./PU 36 PU/pallet 36 PU/pallet 36 PU/pallet 24 PU/pallet 24 PU/pallet 24 PU/pallet 18 PU/pallet 18 PU/pallet 18 PU/pallet |



| Illustration | Item number | Description | Application | PU PU/pallet |
|---|--|--|---|---|
|  | 100944 100945 100946 100947 100948 100949 100950 101809 100952 100954 100955 100956 | Hooked wire, 125 mm Hooked wire, 250 mm Hooked wire, 375 mm Hooked wire, 500 mm Hooked wire, 750 mm Hooked wire, 1,000 mm Hooked wire, 1,250 mm Hooked wire, 1,500 mm Hooked wire, 1,750 mm Hooked wire, 2,000 mm Hooked wire, 2,500 mm Hooked wire, 3,000 mm Custom lengths on request Hooked wire according to EN 13964 |  | 100 pcs./PU 300 PU/pallet 200 PU/pallet 150 PU/pallet 100 PU/pallet 100 PU/pallet 100 PU/pallet 100 PU/pallet 100 PU/pallet 50 PU/pallet 50 PU/pallet 50 PU/pallet 50 PU/pallet |
|  | 100960 | Double spring clip, equilateral |  | 100 pcs./PU 105 PU/pallet |
|  | 100961 100962 100963 101810 | Easy-span hanger, hooked wire/hooked wire Easy-span hanger, HH, ~ 200 - 300 mm Easy-span hanger, HH, ~ 300 - 600 mm Easy-span hanger, HH, ~ 500 - 1,000 mm Easy-span hanger, HH, ~ 1,000 - 2,000 mm |  | 100 pcs./PU 50 PU/pallet 30 PU/pallet 20 PU/pallet 20 PU/pallet |
|  | 100965 100966 100967 100968 | Easy-span hanger, hooked wire/eyelet wire Easy-span hanger, HE, ~ 200 - 300 mm Easy-span hanger, HE, ~ 300 - 600 mm Easy-span hanger, HE, ~ 500 - 1,000 mm Easy-span hanger, HE, ~ 1,000 - 2,000 mm |  | 100 pcs./PU 50 PU/pallet 30 PU/pallet 20 PU/pallet 10 PU/pallet |
|  | 100958 100959 | Hooked wire with double spring clip, 125 mm, bottom part U-1 Hooked wire with double spring clip, 250 mm, bottom part U-2 |  | 100 pcs./PU 96 PU/pallet 100 pcs./PU 50 PU/pallet |
|  | 100926 | Quick hanger for T-profile Initial testing according to EN 13964, 0.25 kN |  | 100 pcs./PU 84 PU/pallet |
|  | 100927 | Quick hanger for T-profile, Klick Fix II with mounted safety plate Initial testing according to EN 13964, 0.32 kN |  | 100 pcs./PU 170 PU/pallet |

| Illustration | Item number | Description | Application | PU PU/pallet |
|--|-------------|--|--|------------------------------|
|  | 100975 | Vernier suspended bracket, bottom part for T-profile Initial testing according to EN 13964, 0.42 kN |  | 100 pcs./PU 220 PU/pallet |
|  | 100969 | Vernier short hanger, set 40 - 80 mm for T-profile and double-T-profile |  | 100 pcs./PU 220 PU/pallet |
| | 100970 | Vernier short hanger, set 60 - 100 mm for T-profile and double-T-profile | | 100 pcs./PU 220 PU/pallet |
| | 100971 | Vernier short hanger, set 80 - 120 mm for T-profile and double-T-profile | | 100 pcs./PU 220 PU/pallet |
|  | 100972 | Vernier short hanger, top part 47 mm |  | 100 pcs./PU |
| | 100973 | Vernier short hanger, top part 72 mm | | 100 pcs./PU |
| | 100974 | Vernier short hanger, top part 100 mm | | 100 pcs./PU |
| | | Initial testing according to EN 13964, 0.40 kN | | |
|  | 100978 | Vernier short hanger, bottom part for T-profile and double-T-profile |  | 100 pcs./PU |



| Illustration | Item number | Description | Application | PU PU/pallet |
|---|-------------|--|---|------------------------------|
|  | 101620 | Connector, CD 60/27, clamping profile Initial testing according to EN 13964, 0.57 kN |  | 100 pcs./PU 96 PU/pallet |
|  | 101808 | Quick hanger for clamping profile Initial testing according to EN 13964, 0.25 kN |  | 100 pcs./PU 170 PU/pallet |
|  | 100976 | Vernier suspended bracket, bottom part for clamping profile |  | 100 pcs./PU 220 PU/pallet |
|  | 100979 | Vernier short hanger, bottom part, clamping profile Initial testing according to EN 13964, 0.38 kN |  | 100 pcs./PU 220 PU/pallet |
|  | 100929 | Connector, longitudinal, clamping profile |  | 100 pcs./PU 96 PU/pallet |

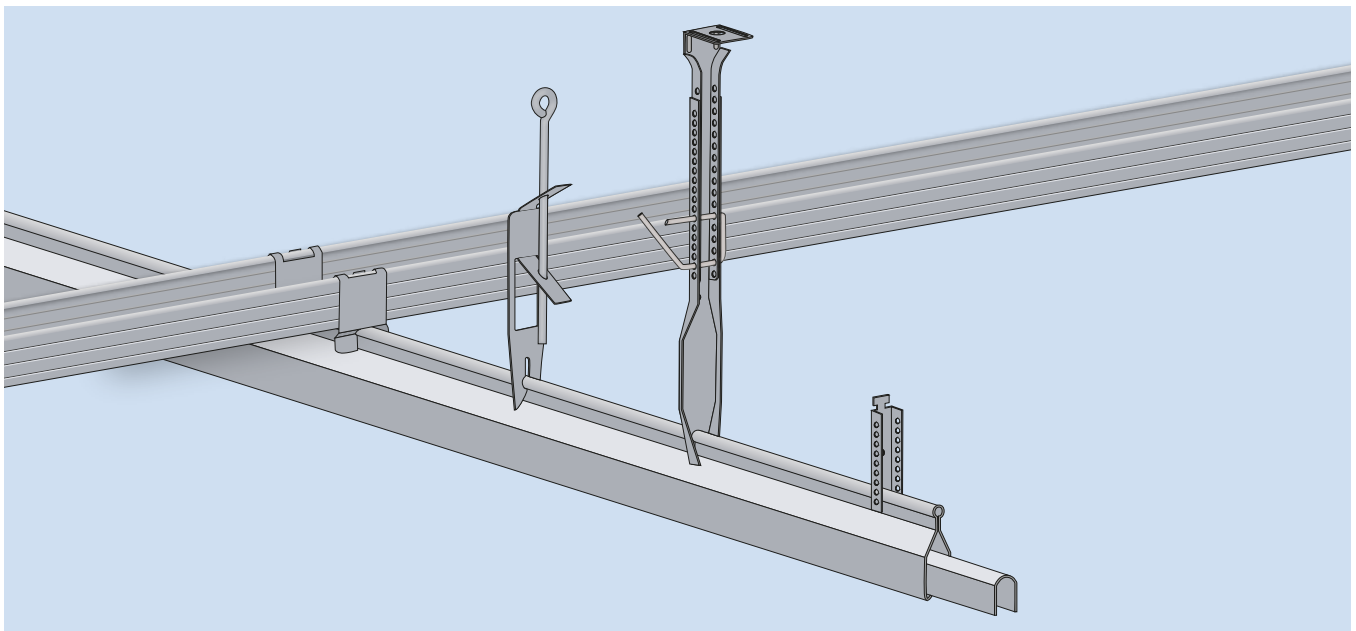

| Illustration | Item number | Description | Dimensions | PU PU/pallet |
|---|-------------|--|--------------|--------------------------------|
|  | 100990 | Wafer head screw FN 35 with needle point To connect hangers to wooden elements | 5.1 x 35 mm | 100 pcs./PU |
|  | 100991 | Drywall screw SBS TN 25 with countersunk head and needle point | 3.5 x 25 mm | 1,000 pcs./PU 540 PU/pallet |
| | 100992 | Drywall screw SBS TN 35 with countersunk head and needle point To mount plasterboards to metal framework (up to max. 0.7 mm without pre-drilling) | 3.5 x 35 mm | 1,000 pcs./PU 438 PU/pallet |
|  | 100993 | Drywall screw SBS TB 35 with countersunk head and drill bit To mount plasterboards to metal framework from 0.7 mm to 2.25 mm sheet metal thickness | 3.5 x 35 mm | 1,000 pcs./PU 438 PU/pallet |
|  | 100994 | LN 9.5 tapping screw with needle point To fasten suspended brackets and sheet steel profiles up to max. 0.7 mm sheet thickness | 3.5 x 9.5 mm | 1,000 pcs./PU 612 PU/pallet |
|  | 100995 | Perforated panel screw SN 30 with needle point Phosphated special screw with pressed-on small countersunk head (cross slot PH2) | 3.5 x 30 mm | 1,000 pcs./PU 468 PU/pallet |
| | 102918 | Perforated panel screw SN 30, on tape for use with autofeed screwdrivers | 3.5 x 30 mm | 1,000 pcs./PU 240 PU/pallet |
|  | 100996 | Perforated panel screw SN 40 with needle point Phosphated special screw with pressed-on small countersunk head (cross slot PH2) | 3.5 x 40 mm | 1,000 pcs./PU |
|  | 101705 | Perforated panel screw TTP PLUS, TB 23 with countersunk head and drill bit Corrosion-resistant special screw with countersunk head (cross slot PH2) Recommended for VoglThermotec panels PLUS (containing graphite) | 3.5 x 23 mm | 1,000 pcs./PU |
|  | 101801 | Perforated panel screw TTP PLUS, SN 35 with needle point Corrosion-resistant special screw with cutting ring head (cross slot PH2) Recommended for VoglThermotec panels PLUS (containing graphite) | 3.5 x 35 mm | 1,000 pcs./PU |